



SGC61A thru SGC67A/SGC0601A thru SGC0607A

Surface Mount Glass Passivated Rectifier
Reverse Voltage 50~1000V Forward Current 6A

Features

- Glass passivated standard rectifiers
- Ideal for automated placement
- Low forward voltage drop
- Low leakage current
- Moisture sensitivity: level 1, per J-STD-020
- Solder dip 260 °C, 10 s
- Low profile - typical height of 1.1 mm

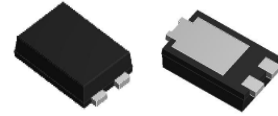

eSGC (TO-277)

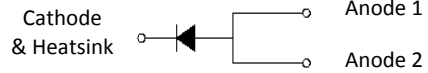

Typical Applications

For use of general purpose rectification in lighting, cellular phone, portable device, power supplies, and other consumer applications.

Maximum Ratings (TA = 25 °C unless otherwise noted)									
Parameter	Symbol	SGC61A	SGC62A	SGC63A	SGC64A	SGC65A	SGC66A	SGC67A	Unit
		SGC0601A	SGC0602A	SGC0603A	SGC0604A	SGC0605A	SGC0606A	SGC0607A	
Maximum repetitive peak reverse voltage	VRRM	50	100	200	400	600	800	1000	V
Maximum RMS voltage	VRMS	35	70	140	280	420	560	700	V
Maximum DC blocking voltage	VDC	50	100	200	400	600	800	1000	V
Maximum average forward rectified current	IF(AV) ¹⁾	3.0							A
	IF(AV) ²⁾	6.0							
Peak forward surge current 8.3 ms single half sine-wave superimposed on rated load	IFSM	180							A
Operating junction and storage temperature range	TJ, TSTG	- 55 to + 150							°C

Electrical Characteristics (TA = 25 °C unless otherwise noted)										
Parameter	Test Conditions	Symbol	SGC61A	SGC62A	SGC63A	SGC64A	SGC65A	SGC66A	SGC67A	Unit
			SGC0601A	SGC0602A	SGC0603A	SGC0604A	SGC0605A	SGC0606A	SGC0607A	
Instantaneous forward voltage	IF=6 A ,TA=25°C	VF	TYP:0.94; MAX:1.1							Volts
Maximum DC reverse current at rated DC blocking voltage	TA=25°C	IR	10							µA
	TA=125°C		250							
Typical reverse recovery time	IF=0.5A,IR=1.0A, t _{rr} =0.25A	t _{rr}	4							uS
Typical junction capacitance	4.0 V, 1 MHz	CJ	35							pF
Typical thermal resistance	junction to ambient	R _{θJA} ¹⁾	72							°C/W
	junction to mount	R _{θJM} ²⁾	5							°C/W

Notes: 1)Thermal resistance R_{θJA} is junction to ambient. Free air,mounted on P.C.B with recommended copper pad area,2 OZ,FR4

2)Thermal resistance R_{θJM} is junction to mount.Mounted on P.C.B with 30*30mm copper pad area



SGC61A thru SGC67A/SGC0601A thru SGC0607A

Surface Mount Glass Passivated Rectifier
Reverse Voltage 50~1000V Forward Current 6A

Ratings and Characteristics Curves

(TA = 25°C unless otherwise noted)

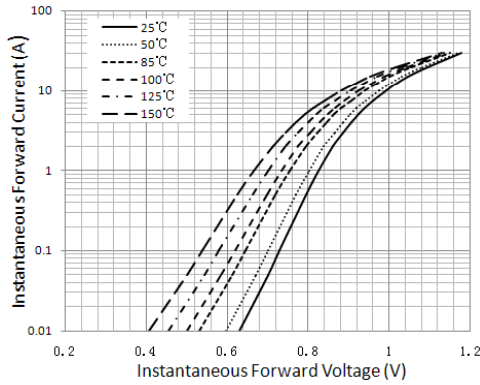

Figure 1. Typical Instantaneous Forward Characteristics

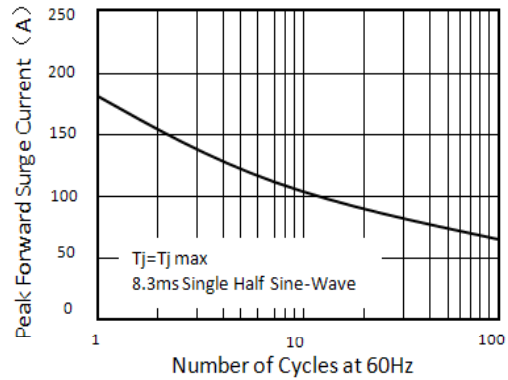

Figure 2. Maximum Non-Repetitive Peak Forward Surge Current

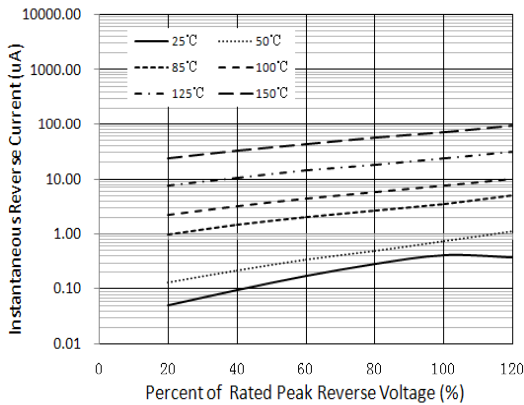

Figure 3. Typical Reverse Characteristics

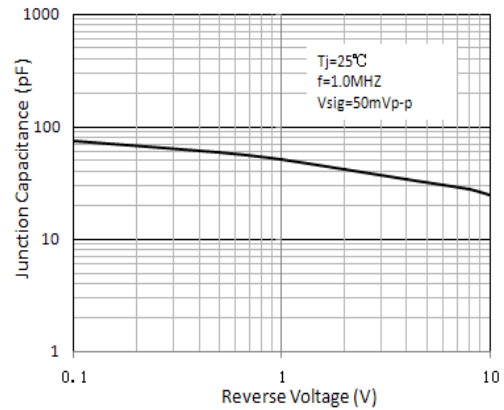

Figure 4. Typical Junction Capacitance

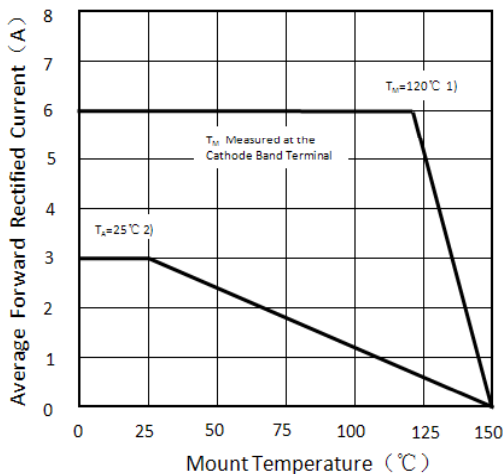

Figure 5. Forward Current Derating Curve

- 1) Mounted on P.C.B with 30*30mm copper pad area
- 2) Fre air, Mounted on recommended copper pad area FR4 PCB ($R_{\theta JA} = 72^\circ\text{C/W}$)



SGC61A thru SGC67A/SGC0601A thru SGC0607A

Surface Mount Glass Passivated Rectifier
Reverse Voltage 50~1000V Forward Current 6A

Package Outline Dimensions

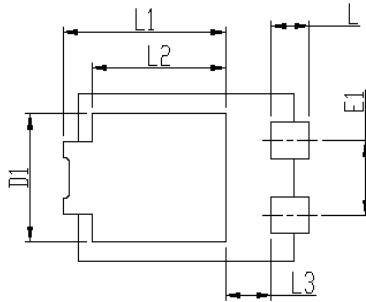
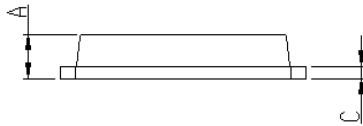
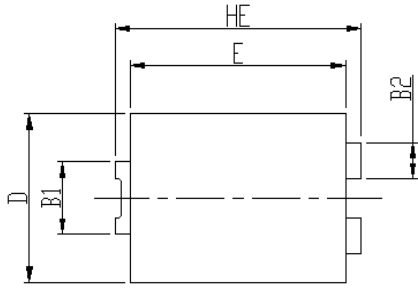

DIM	Unit: mm		Unit: inch	
	MIN	MAX	MIN	MAX
HE	6.4	6.6	0.252	0.260
E	5.6	5.8	0.220	0.228
D	4.1	4.3	0.161	0.169
B1	1.7	1.9	0.067	0.075
B2	0.8	1	0.031	0.039
A	1.05	1.2	0.041	0.047
C	0.3	0.4	0.012	0.016
L	0.85	1.1	0.033	0.043
L1	4.2	4.4	0.165	0.173
L2	3.52 Typ.		0.139 Typ.	
L3	1.1	1.4	0.043	0.055
D1	3	3.3	0.118	0.130
E1	1.86 Typ.		0.073 Typ.	

Soldering footprint

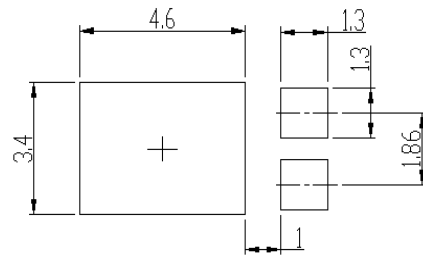

Packing Information

Packing quantities:

5000 pcs/Reel, 12mm Tape, 13" Reel

Tape & Reel Specification

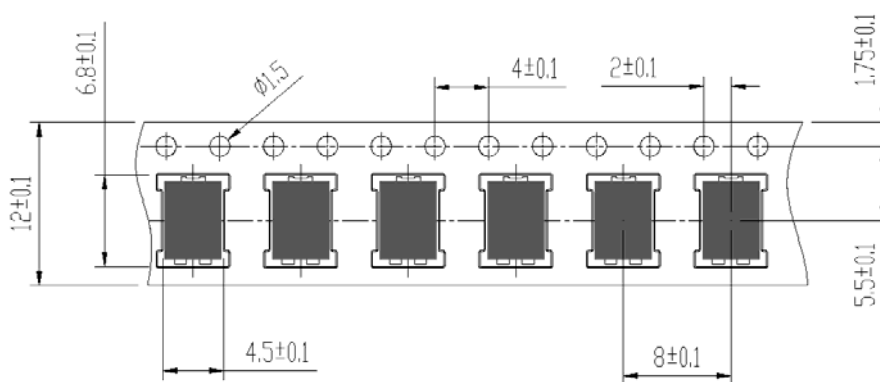



SGC61A thru SGC67A/SGC0601A thru SGC0607A

Surface Mount Glass Passivated Rectifier
Reverse Voltage 50~1000V Forward Current 6A

Disclaimers

These materials are intended as a reference to assist our customers in the selection of the Suzhou Good-Ark product best suited to the customer's application; they do not convey any license under any intellectual property rights, or any other rights, belonging to Suzhou Good-Ark Electronics Co., Ltd. or a third party.

Suzhou Good-Ark Electronics Co., Ltd. assumes no responsibility for any damage, or infringement of any third-party's rights, originating in the use of any product data, diagrams, charts, programs, algorithms, or circuit application examples contained in these materials.

All information contained in these materials, including product data, diagrams, charts, programs and algorithms represents information on products at the time of publication of these materials, and are subject to change by Suzhou Good-Ark Electronics Co., Ltd. without notice due to product improvements or other reasons. It is therefore recommended that customers contact Suzhou Good-Ark Electronics Co., Ltd. or an authorized Suzhou Good-Ark Electronics Co., Ltd. for the latest product information before purchasing a product listed herein. The information described here may contain technical inaccuracies or typographical errors. Suzhou Good-Ark Electronics Co., Ltd. assumes no responsibility for any damage, liability, or other loss rising from these inaccuracies or errors. Please also pay attention to information published by Suzhou Good-Ark Electronics Co., Ltd. by various means, including our website home page.
(<http://www.goodark.com>)

When using any or all of the information contained in these materials, including product data, diagrams, charts, programs, and algorithms, Please be sure to evaluate all information as a total system before making a final decision on the applicability of the information and products. Suzhou Good-Ark Electronics Co., Ltd. assumes no responsibility for any damage, liability or other loss resulting from the information contained herein.

The prior written approval of Suzhou Good-Ark Electronics Co., Ltd. is necessary to reprint or reproduce in whole or in part these materials.

Please contact Suzhou Good-Ark Electronics Co., Ltd. or an authorized distributor for further details on these materials or the products contained herein.